





Little Wedding Cake  pg 254  
Little Wedding Cake

Portatorta in Plastica pg 256  
Plastic Cake Stand

Portatorta Metal pg 293  
Metal Cake Stand

Tavole in Plastica pg 294  
Plastic Boards

Stampi Cottura e Fontanina pg 295  
Baking Moulds and Fountain

Alzate Portatorta Poly pg 298  
Poly Cake Stands

Alzate Portatorta Junior pg 307  
Junior Cake Stands

**Little  
Wedding  
Cake**



## LITTLE WEDDING CAKE

COD. - ITEM	MIS. - DIM.	PIANI - LEVELS	PORT.
COD. 201	h 58 cm	Ø52 - 35 - 18 cm	95 - 105



COD. - ITEM	MIS. - DIM.	PIANI - LEVELS	PORT.
COD. 202	h 58 cm	51x43 - 36x26 - 20x10 cm	100-110



**Little  
Wedding  
Cake**



## LITTLE WEDDING CAKE

COD. - ITEM	MIS. - DIM.	PIANI - LEVELS	PORT.
COD. 203	h 58 cm	51x43 - 36x26 - 20x10 cm	100-110



COD. - ITEM	MIS. - DIM.	PIANI - LEVELS	PORT.
COD. 204	h 58 cm	49x49 - 34x34 - 18x18 cm	100-110







CLASSICHE QUADRE CLASSICAL SQUARE

COD. - ITEM	MIS. - DIM.	PIANI - LEVELS	PORT.
COD. 101	h 120 cm	25 x 25 - 30 x 30 - 35 x 35 - 40 x 40 - 45 x 45 cm	145-155

FONANINA ELETTRICA FORNITA SU RICHIESTA (COD. FONANINA)  
ELECTRIC FOUNTAIN ON REQUEST (CODE FONANINA)



COD. - ITEM	MIS. - DIM.	PIANI - LEVELS	PORT.
COD. 102	h 96 cm	25 x 25 - 30 x 30 - 35 x 35 - 40 x 40 - 45 x 45 cm	145-155



## CLASSICHE TONDE CLASSICAL ROUND

COD. - ITEM	MIS. - DIM.	PIANI - LEVELS	PORT.
<b>COD. 103</b>	h 120 cm	Ø 25 - 30 - 35 - 40 - 48 cm	100-110

FONANTINA ELETTRICA FORNITA SU RICHIESTA (COD. FONTANINA)  
ELECTRIC FOUNTAIN ON REQUEST (CODE FONTANINA)



COD. - ITEM	MIS. - DIM.	PIANI - LEVELS	PORT.
<b>COD. 104</b>	h 86 cm	Ø 25 - 30 - 35 - 40 - 48 cm	100-110



## RICAMBI SPARE-PARTS

Perni in acciaio inox 18/10.  
Colonna in materiale plastico per alimenti, lavabile e con dado interno in metallo.

*Stainless steel pivots.  
Plastic column with metal screw inside. Easy to wash.*

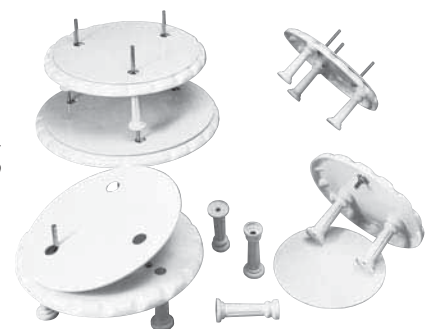



## FONTANA FOUNTAIN

COD. - ITEM	MIS. - DIM.	PIANI - LEVELS	PORT.
COD. 111	Ø 100 cm	Ø 85 - 48 - 25 cm - h 100 cm	90 - 100

FONTANINA ELETTRICA FORNITA SU RICHIESTA (COD. FONTANINA)  
ELECTRIC FOUNTAIN ON REQUEST (CODE FONTANINA)





## AMERICANA AMERICAN

COD. - ITEM	MIS. - DIM.	PIANI - LEVELS	PORT.
COD. 112	h 47 cm	Ø 85 - 55 - 25 cm	90 - 100



COD. - ITEM	MIS. - DIM.	PIANI - LEVELS	PORT.
COD. 118	h 23 cm	Ø 85	85 - 95



COD. - ITEM	MIS. - DIM.	PIANI - LEVELS	PORT.
COD. 118/F	h 30 cm	Ø 85 - h 30 cm	70 - 80

FONTANINA ELETTRICA FORNITA SU RICHIESTA (COD. FONTANINA)  
ELECTRIC FOUNTAIN ON REQUEST (CODE FONTANINA)







COLONNE COLUMNS

COD. - ITEM	MIS. - DIM.	PIANI - LEVELS	PORT.
<b>COD. 113/A</b>	h 110 cm	Ø cm 18 - 22 - 24 - 28 - 32 - 36 cm	70 - 80



COD. - ITEM	MIS. - DIM.	PIANI - LEVELS	PORT.
<b>COD. 113/B</b>	h 110 cm	Ø cm 18 - 22 - 24 - 28 - 32 - 36 cm	70 - 80



VELIERO VESSEL

COD. - ITEM MIS. - DIM. PORT.

COD. 116 150 x 50 - h130 cm 95 - 105







## CULLA CRADLE

COD. - ITEM	MIS. - DIM.	PIANI - LEVEL	PORT.
<b>COD. 117</b>	55 x 50 - h 38 cm	(1) 50x30 cm	25 - 30

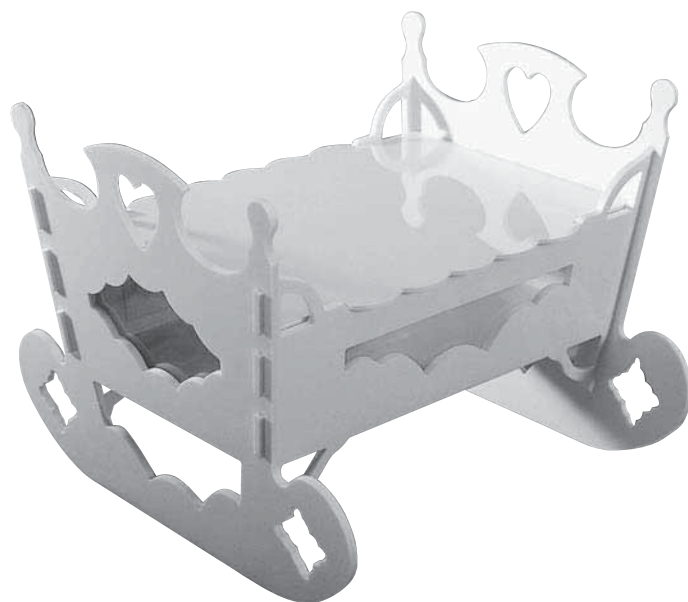

COD. - ITEM	PORT.
<b>COD. 117 + COD. 118</b>	140 - 150

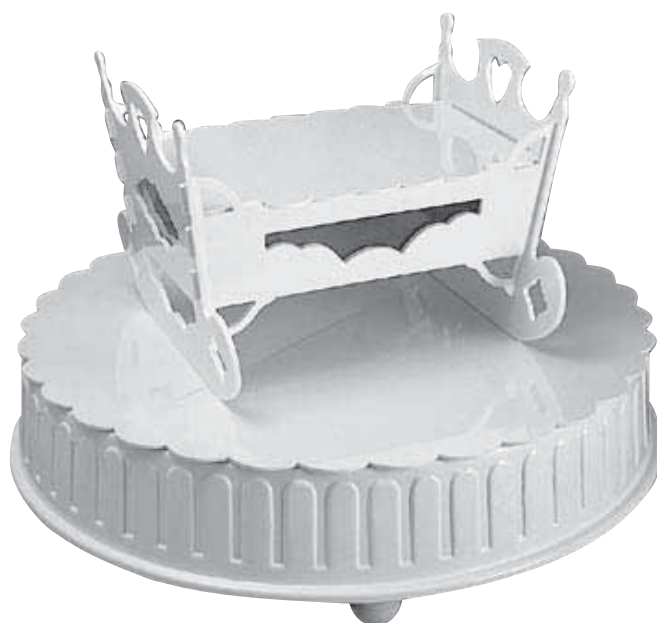



## PONTE BRIDGE

**COD. - ITEM**    **MIS. - DIM.**    **PIANI - LEVEL**    **PORT.**

**COD. 121**    m 85 x 35 h 45 cm    (4) 29 x 19 - (1) 29 x 38    70 - 80

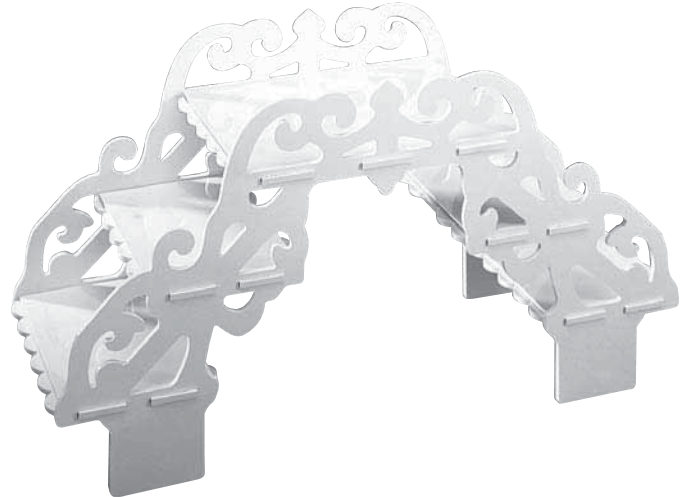

**COD. - ITEM**

**PORT.**

**COD. 121 + COD. 118/F**

135 - 145

FONTANINA ELETTRICA FORNITA SU RICHIESTA (COD. FONTANINA)  
ELECTRIC FOUNTAIN ON REQUEST (CODE FONTANINA)

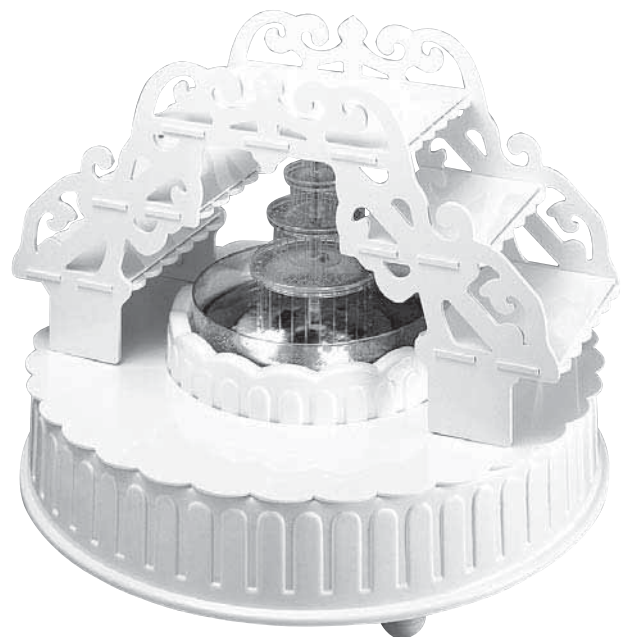



## CONCHIGLIA SHELL

**COD. - ITEM**   **MIS. - DIM.**   **PORT.**

**COD. 122**   Ø 60 cm - h 70 cm   35 - 45



La base della conchiglia può essere riempita di ghiaccio per mantenere freschi i vostri prodotti.  
*The cake stand base can be filled with ice to keep fresh your food.*

**COD. - ITEM**

**PORT.**

**COD. 122 + COD. 118**

120 - 140







## MARGHERITA DAISY

COD. - ITEM	MIS. - DIM.	PETALI - PETALS	PORT.
COD. 123	Ø 70 cm	33x20 cm	80 - 90

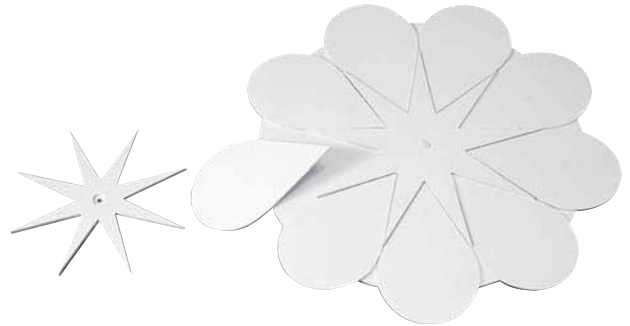

Porta torta a petali variabili a seconda delle esigenze.  
Fornita con due raggiera da 8/9 petali

*Cake stand with changeable petals according to your request.  
Endowed with two sunbursts for 8/9 petals*

COD. - ITEM	MIS. - DIM.	PETALI - PETALS	PORT.
COD. 124	Ø 90 cm	40x25 cm	115 - 125

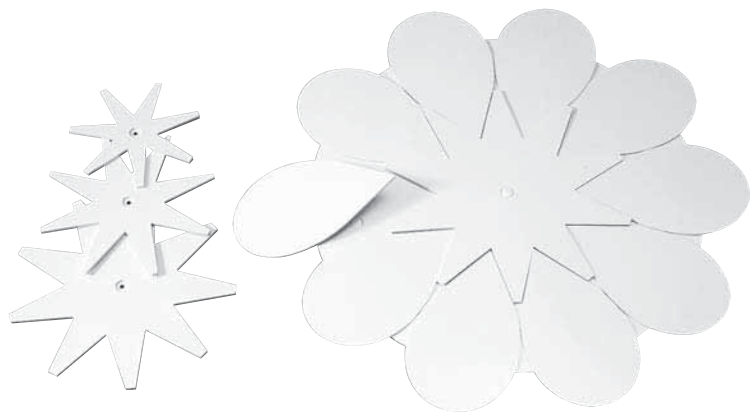

Porta torta a petali variabili a seconda delle esigenze.  
Fornita con quattro raggiera da 7/8/9/10 petali

*Cake stand with changeable petals according to your request.  
Endowed with four sunbursts for 7/8/9/10 petals*





## DUE CUORI TWO HEARTS

**COD. - ITEM** **MIS. - DIM.** **PORT.**

**COD. 126/B** 85x45 cm 40 - 45



**COD. - ITEM** **MIS. - DIM.** **PORT.**

**COD. 126/A** 120x65 cm 80 - 90

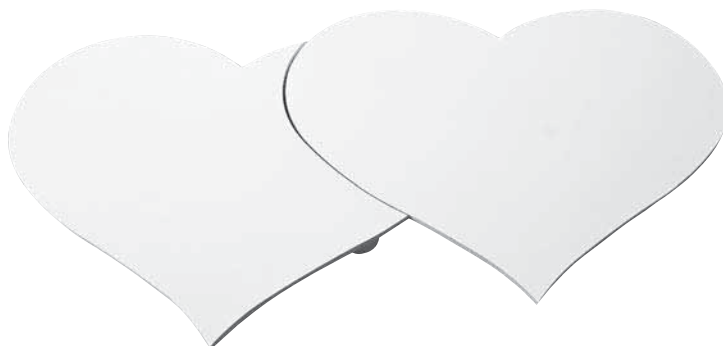

È possibile usare singolarmente il cuore intero.  
*It is possible to use the whole heart separately.*

TORRE EIFFEL

COD. - ITEM MIS. - DIM. PORT.

COD. 127 73x73 - h 140 cm 85 - 95

FONANINA ELETTRICA FORNITA SU RICHIESTA (COD. FONTANINA)  
ELECTRIC FOUNTAIN ON REQUEST (CODE FONTANINA)

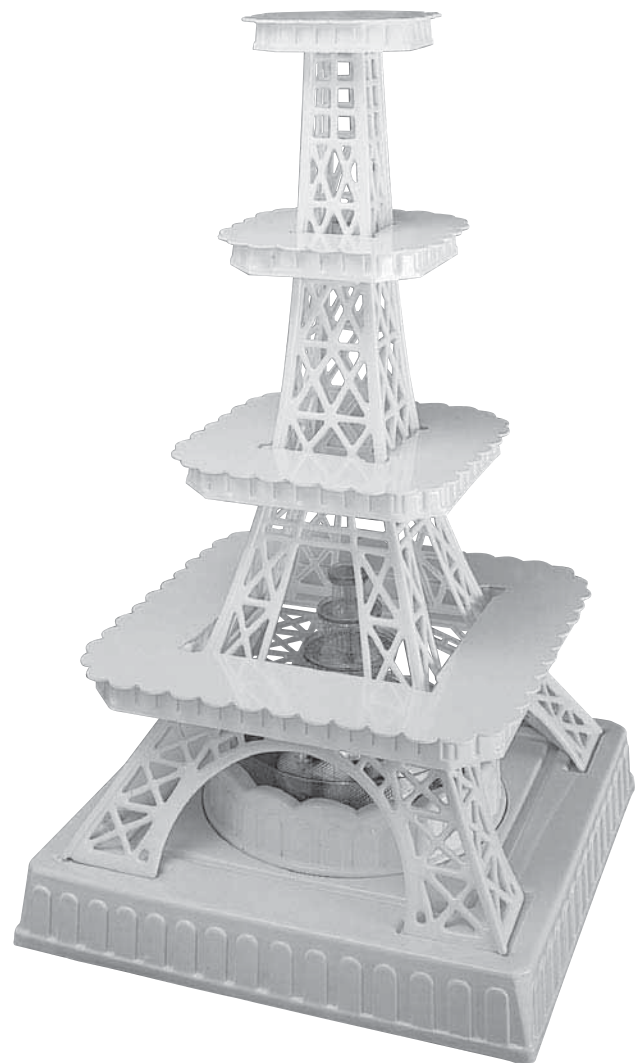





## CORNUCOPIA

COD. - ITEM MIS. - DIM.

COD. 128 54x29 - h 62 cm



COD. - ITEM

PORT.

COD. 128 + COD. 118

90 - 100





CICOGNA STORK

COD. - ITEM MIS. - DIM. PORT.

COD. 129 Ø 25,30 e 35 cm - h 125 cm 55 - 65





COLONNA QUADRA SQUARE COLUMN

COD. - ITEM	MIS. - DIM.	PIANI - LEVELS	PORT.
COD. 130	h 80 cm	40 x 40 - 35 x 35 - 30 x 30 - 25 x 25 cm	80 - 85





## COLONNA TONDA ROUND COLUMN

COD. - ITEM	MIS. - DIM.	PIANI - LEVELS	PORT.
COD. 131	h 80 cm	Ø 39 - 34 - 29 - 24 cm	40 - 50



COLONNA CUORE HEART COLUMN

COD. - ITEM	MIS. - DIM.	PIANI - LEVELS	PORT.
COD. 132	h 80 cm	40 x 34 - 35 x 30 - 30 x 26 - 25 x 21 cm	40 - 50





## SCALA STAIRWAY

COD. - ITEM	MIS. - DIM.	PIANI - LEVELS	PORT.
COD. 150	80x60 -h80cm	23 x 18 - 29 x 17 - 39 x 19 - 50 x 22 - 60 x 25 cm	75 - 85









## CIGNO SWAN

COD. - ITEM	MIS. - DIM.	PIANI - LEVELS	PORT.
<b>COD. 138</b>	h 150 cm	(20) Ø cm 26 - (1) Ø cm 38	260 - 270

FONTANINA ELETTRICA FORNITA SU RICHIESTA (COD. FONTANINA)  
ELECTRIC FOUNTAIN ON REQUEST (CODE FONTANINA)



COD. - ITEM	MIS. - DIM.	PIANI - LEVELS	PORT.
<b>COD. 135</b>	h 42 cm	(4) Ø cm 26 - (1) Ø cm 38	65 - 75



COD. - ITEM	MIS. - DIM.	PIANI - LEVELS	PORT.
<b>COD. 136</b>	h 46 cm	(8) Ø cm 26 - (1) Ø cm 62	140 - 150



COD. - ITEM	MIS. - DIM.	PIANI - LEVELS	PORT.
<b>COD. 137</b>	h 57 cm	(8) Ø cm 26 - (1) Ø cm 76	170 - 180

FONTANINA ELETTRICA FORNITA SU RICHIESTA (COD. FONTANINA)  
ELECTRIC FOUNTAIN ON REQUEST (CODE FONTANINA)





ROMANTICA ROMANTIC

COD. - ITEM	MIS. - DIM.	PIANI - LEVELS	PORT.
COD. 152	Ø 80 - h70 cm	(5) Ø 26 - (5) Ø 20 - (1) Ø 34 cm	100 - 110



NINFEA PICCOLA LITTLE WATER LILY

COD. - ITEM	MIS. - DIM.	PIANI - LEVELS	PORT.
COD. 151/A	105x97 - h83 cm	(8) Ø 25 - (1) 42x27 cm	120 - 130







## SEMIRAMIDE SEMIRAMIS

COD. - ITEM	MIS. - DIM.	PIANI - LEVELS	PORT.
COD. 153	100x54 - h88 cm	(3) Ø 32 - (3) Ø 26 - (1) Ø 38 cm	90 - 100



## MANHATTAN

COD. - ITEM	MIS. - DIM.	PIANI - LEVELS	PORT.
COD. 159	Ø65 - h85 cm	(7) Ø 26 - (1) Ø 38 cm	100 - 110







## INGLESE ENGLISH

COD. - ITEM	MIS. - DIM.	PIANI - LEVELS	PORT.
<b>COD. 155</b>	h 65 cm	Ø 68 - 48 - 28 cm	60-70



COD. - ITEM	MIS. - DIM.	PIANI - LEVELS	PORT.
<b>COD. 156</b>	h 85 cm	Ø 68 - 48 - 28 cm	75 - 85



COD. - ITEM	MIS. - DIM.	PIANI - LEVELS	PORT.
<b>COD. 157</b>	h 85 cm	Ø 68 - 48 - 28 cm	95 - 105

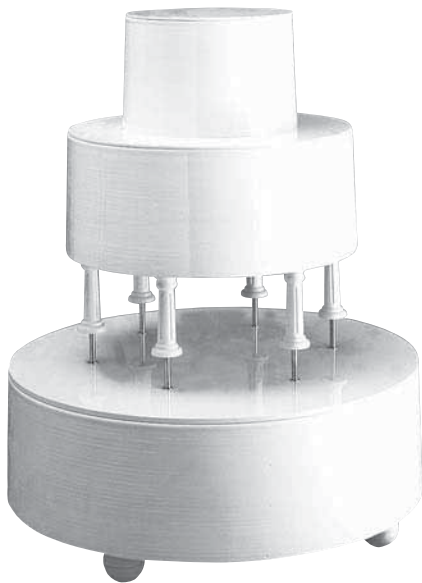

COD. - ITEM	MIS. - DIM.	PIANI - LEVELS	PORT.
<b>COD. 158</b>	h 105 cm	Ø 68 - 48 - 28 cm	105 - 115

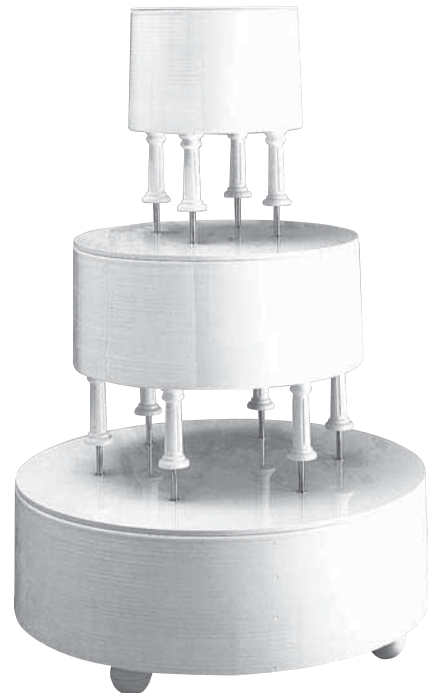

## RICAMBI SPARE PARTS

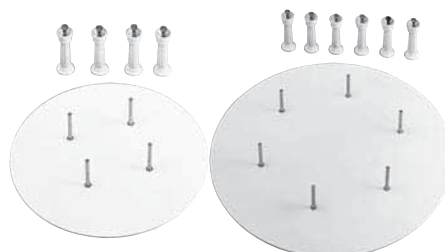

COD. - ITEM	COD. - ITEM
<b>COD. KIT 1</b>	piatto - plate Ø 48 + 4 col.
<b>COD. KIT 2</b>	piatto - plate Ø 68 + 6 col.





## FLORA

COD. - ITEM	MIS. - DIM.	PIANI - LEVELS	PORT.
<b>COD. 160</b>	Ø 110 - h 130 cm	(4) Ø 34 cm - (7) Ø 26 cm - (1) Ø 32 cm	145 - 155

FONTANINA ELETTRICA FORNITA SU RICHIESTA (COD. FONTANINA)  
ELECTRIC FOUNTAIN ON REQUEST (CODE FONTANINA)



COD. - ITEM	MIS. - DIM.	PIANI - LEVELS	PORT.
<b>COD. 161</b>	Ø 110 - h 51 cm	(4) Ø 34 cm - (1) Ø 55 cm	105 - 115

FONTANINA ELETTRICA FORNITA SU RICHIESTA (COD. FONTANINA)  
ELECTRIC FOUNTAIN ON REQUEST (CODE FONTANINA)



COD. - ITEM	MIS. - DIM.	PIANI - LEVELS	PORT.
<b>COD. 163</b>	Ø 40 - h 45 cm	(3) Ø 26 cm - (1) Ø 32 cm	45 - 55



COD. - ITEM	MIS. - DIM.	PIANI - LEVELS	PORT.
<b>COD. 162</b>	Ø 70 - h 42 cm	(4) Ø 26 cm - (1) Ø 45 cm	80 - 90





## GAZEBO

**COD. - ITEM**    **MIS. - DIM.**    **PORT.**

**COD. 170**    Ø 85 - h 90 cm    60 - 80

**FONANINA ELETTRICA FORNITA SU RICHIESTA (COD. FONTANINA)**  
**ELECTRIC FOUNTAIN ON REQUEST (CODE FONTANINA)**







## DAISY

COD. - ITEM	MIS. - DIM.	PIANI - LEVELS	PORT.
COD. 180	Ø 90 - h45 cm	(6) Ø 28 cm - (1) Ø cm 48 (1) Ø 30 cm	120 - 130



## MEMPHIS

COD. - ITEM	MIS. - DIM.	PIANI - LEVELS	PORT.
COD. 183	Ø 70 - h50 cm	(4) Ø 30 cm	50 - 60





## TRIFOGLIO CLOVER

COD. - ITEM	MIS. - DIM.	PIANI - LEVELS	PORT.
<b>COD. 188</b>	65 x 62 cm - h 38 cm	(3) Ø 28 cm - (3) Ø 20 cm - (1) Ø 22 cm	40 - 45



## RIO

COD. - ITEM	MIS. - DIM.	PIANI - LEVELS	PORT.
<b>COD. 189</b>	80 x 70 cm - h 46 cm	(5) Ø 28 cm	55 - 65







BIGNOLATA CROQUEMBOUCHE

COD. - ITEM MIS. - DIM.

COD. 184 Ø 52 - h40 cm



COD. - ITEM MIS. - DIM.

COD. 185 Ø 62 - h50 cm





VELOCIPEDE

COD. - ITEM	MIS. - DIM.	PIANI - LEVELS	PORT.
<b>COD. 186</b>	90x35-h60 cm (2) Ø 22 cm - (1) Ø 26 cm		25 - 30



COD. - ITEM	PORT.
<b>COD. 186 + COD. 118</b>	110 - 120





## CARROZZINA PRAM

COD. - ITEM	MIS. - DIM.	PIANI - LEVELS	PORT.
COD. 187	70x35 - h62 cm	50x30 cm	25 - 30



COD. - ITEM	PORT.
COD. 187 + COD. 118	110 - 120





## GRADUS

COD. - ITEM	MIS. - DIM.	PIANI - LEVELS	PORT.
<b>COD. 190</b>	88 x 30 cm - h 34 cm	(1) Ø 28 - (1) Ø 26 - (1) Ø 24 - (2) Ø 22 cm	45 - 55



## MILANO

COD. - ITEM	MIS. - DIM.	PIANI - LEVELS	PORT.
<b>COD. 192</b>	62 x 62 cm - h 38 cm	(4) Ø 20 cm - (1) Ø 25 cm	30 - 35







FIORE DI LOTO GRANDE BIG LOTUS FLOWER

COD. - ITEM	MIS. - DIM.	PIANI - LEVELS:	PORT.
COD. 196/B	Ø 90 cm - h 25 cm	(5) 20 x 40 - (5) 13 x 24 - (1) Ø 22 cm	60 - 80



FIORE DI LOTO PICCOLA SMALL LOTUS FLOWER

COD. - ITEM	MIS. - DIM.	PIANI - LEVELS:	PORT.
COD. 196	Ø 70 cm - h 25 cm	(5) 32 x 16 - (5) 20 x 10 - (1) Ø 18 cm	55 - 60





COD. - ITEM	MIS. - DIM.	PIANI - LEVELS:
COD. 505	h 38 cm	Ø20 - Ø49 cm



COD. - ITEM	MIS. - DIM.	PIANI - LEVELS:
COD. 506	h 38 cm	Ø20 - Ø49 cm







**COD. - ITEM**   **MIS. - DIM.**   **PIANI - LEVELS:**  
**COD. 507**   h 41 cm    $\emptyset$  15 -  $\emptyset$  30 cm



**COD. - ITEM**   **MIS. - DIM.**   **PIANI - LEVELS:**  
**COD. 508**   h 41 cm    $\emptyset$  25 -  $\emptyset$  49 cm



**COD. - ITEM**   **DIM.**   **PIANI - LEVELS:**  
**COD. 509**   h 75 cm    $\emptyset$  15 -  $\emptyset$  30 -  $\emptyset$  50 cm





COD. - ITEM	MIS. - DIM.	PIANI - LEVELS:
COD. 504	h 125 cm	020 - 022 - 026 - 028 - 030 cm





## METAL

COD. - ITEM	PIANI - LEVELS:	MIS. - DIM.	PORT.
<b>METAL 3</b>	3 piani - levels	20-26-32 cm	34-36
<b>METAL 4</b>	4 piani - levels	20-26-32-40 cm	60-62
<b>METAL 5</b>	5 piani - levels	20-26-32-40-45 cm	90-92
<b>METAL 6</b>	6 piani - levels	20-26-32-40-45-50 cm	130-132
<b>METAL 7</b>	7 piani - levels	16-20-26-32-40-45-50 cm	175-180
<b>METAL 8</b>	8 piani - levels	16-20-26-32-40-45-50-55 cm	220-225
<b>METAL 9</b>	9 piani - levels	16-20-26-32-40-45-50-55-60 cm	270-280

Realizzate in resistente alluminio.  
*Made of strong aluminium.*



## PORTA TORTE IN MATERIALE PLASTICO STRONG PLASTIC CAKE STANDS

Resistente, non assorbe odori ed umidità. Spessore 8 mm con piedini a sfera Ø 25 mm o senza piedini, 3 modelli: rotondo, quadrato, rettangolare. Altre forme a richiesta.

*Don't absorb smell and humidity. Thickness 8 mm with plastic balls Ø 25 mm or without, 3 models: round, square, rectangular. Other shapes on request.*

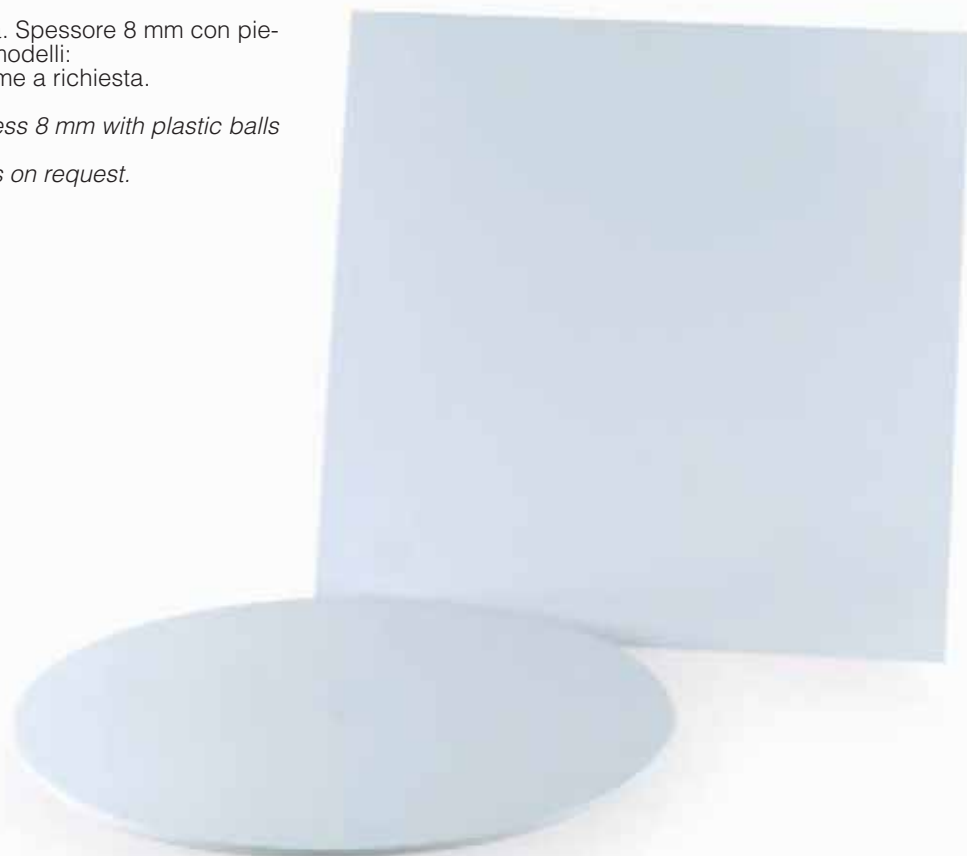

### ROTONDO ROUND

COD. - ITEM	MIS. - DIM.	PIEDINI
<b>COD. TAV Ø 40 C/P</b>	Ø 40 cm.	5
<b>COD. TAV Ø 40 PIA</b>	Ø 40 cm.	no
<b>COD. TAV Ø 50 C/P</b>	Ø 50 cm.	5
<b>COD. TAV Ø 50 PIA</b>	Ø 50 cm.	no
<b>COD. TAV Ø 60 C/P</b>	Ø 60 cm.	5
<b>COD. TAV Ø 60 PIA</b>	Ø 60 cm.	no
<b>COD. TAV Ø 70 C/P</b>	Ø 70 cm.	9
<b>COD. TAV Ø 70 PIA</b>	Ø 70 cm.	no
<b>COD. TAV Ø 80 C/P</b>	Ø 80 cm.	9
<b>COD. TAV Ø 80 PIA</b>	Ø 80 cm.	no
<b>COD. TAV Ø 90 C/P</b>	Ø 90 cm.	9
<b>COD. TAV Ø 90 PIA</b>	Ø 90 cm.	no
<b>COD. TAV Ø 100 C/P</b>	Ø 100 cm.	13
<b>COD. TAV Ø 100 PIA</b>	Ø 100 cm.	no
<b>COD. TAV Ø 120 C/P</b>	Ø 120 cm.	13
<b>COD. TAV Ø 120 PIA</b>	Ø 120 cm.	no

### RETTANGOLARE RECTANGULAR

COD. - ITEM	MIS. - DIM.	PIEDINI
<b>COD. TPP 60X40</b>	40 x 60 cm.	no
<b>COD. TAV 40 X 60 C/P</b>	40 x 60 cm.	5
<b>COD. TAV 50 X 60 C/P</b>	50 x 60 cm.	5
<b>COD. TAV 50 X 60 PIA</b>	50 x 60 cm.	no
<b>COD. TAV 60 X 70 C/P</b>	60 x 70 cm.	9
<b>COD. TAV 60 X 70 PIA</b>	60 x 70 cm.	no
<b>COD. TAV 60 X 80 C/P</b>	60 x 80 cm.	12
<b>COD. TAV 60 X 80 PIA</b>	60 x 80 cm.	no
<b>COD. TAV 70 X 80 C/P</b>	70 x 80 cm.	12
<b>COD. TAV 70 X 80 PIA</b>	70 x 80 cm.	no
<b>COD. TAV 80 X 90 C/P</b>	80 x 90 cm.	20
<b>COD. TAV 80 X 90 PIA</b>	80 x 90 cm.	no
<b>COD. TAV 80 X 100 C/P</b>	80 x 100 cm.	20
<b>COD. TAV 80 X 100 PIA</b>	80 x 100 cm.	no

### QUADRATO SQUARE

COD. - ITEM	MIS. - DIM.	PIEDINI
<b>COD. TAV 50 X 50 C/P</b>	50 x 50 cm.	4
<b>COD. TAV 50 X 50 PIA</b>	50 x 50 cm.	no
<b>COD. TAV 60 X 60 C/P</b>	60 x 60 cm.	5
<b>COD. TAV 60 X 60 PIA</b>	60 x 60 cm.	no
<b>COD. TAV 70 X 70 C/P</b>	70 x 70 cm.	9
<b>COD. TAV 70 X 70 PIA</b>	70 x 70 cm.	no
<b>COD. TAV 80 X 80 C/P</b>	80 x 80 cm.	12
<b>COD. TAV 80 X 80 PIA</b>	80 x 80 cm.	no
<b>COD. TAV 90 X 90 C/P</b>	90 x 90 cm.	16
<b>COD. TAV 90 X 90 PIA</b>	90 x 90 cm.	no



Particolare del piedino.  
*Particular of the support*



## STAMPI COTTURA INOX ST STEEL BAKING MOULDS

COD. - ITEM	DESCR. - DESCRIPTION
SCI01	per base cod. 111/112 - mould for base cod. 111/112
SCI02	per ll° piano cod. 111/112 Ø 48 - mould cod. 111/112 Ø 48 cm
SCI03	per cod. 122 - mould cod. 122
SCI04	set 4 pz. per cod. 116 - mould cod. 116 set 4pcs
SCI07	per base cod. 118/F - mould base cod. 118/F
SCI09	per base cod. 155 Ø 68 cm - mould cod. 155 Ø 68 cm
SCI10	per ll° piano cod. 155 Ø 48 cm - mould cod. 155 Ø 48 cm
SC196GR	per base cod. 196 petalo grande 32x16 cm mould cod. 196 big petal 32x16 cm
SC196PI	per base cod. 196 petalo piccolo 20x10 cm mould cod. 196 small petal 20x10 cm

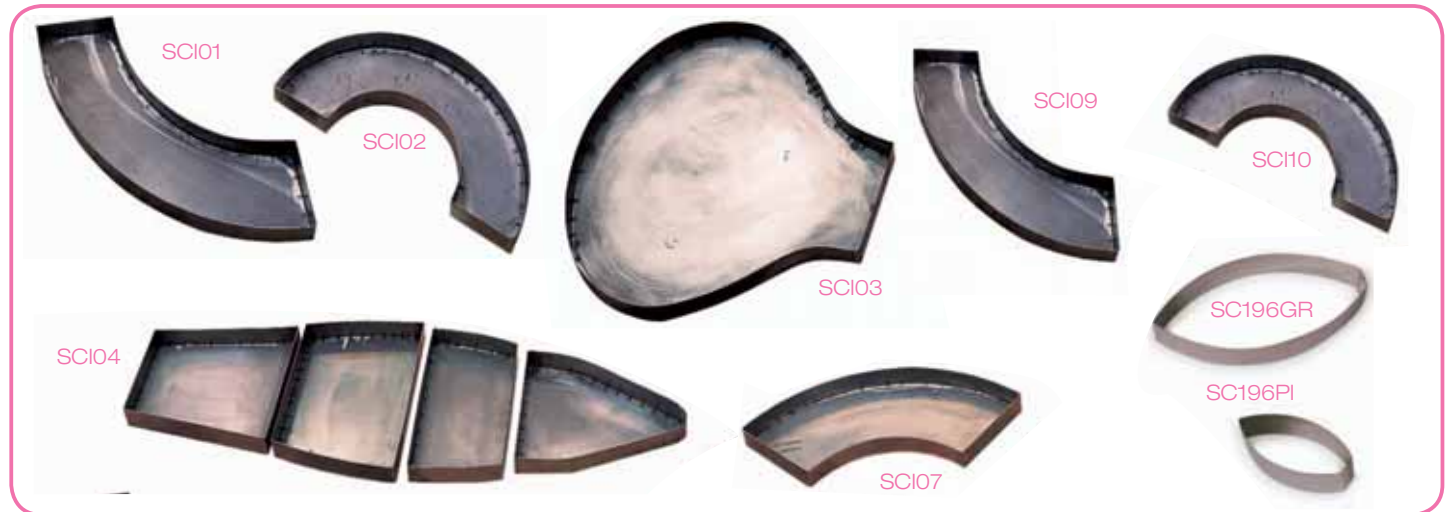

## ACCESSORI ACCESSORIES

Fontana elettrica 12 V  
Electric fountain 12 V

COD. - ITEM	MIS. - DIM.
FONTANINA	Ø 38 cm - h 40 cm



Anello separatore per base Ø 85 cm e per base Ø 115 cm  
Separator ring for base Ø 85 cm and base Ø 115 cm

COD. - ITEM
ANELLO







## DECORAZIONE

Le alzate in materiale plastico possono essere decorate direttamente sulla loro superficie, senza l'applicazione di alcun collante, con un pennello, per creare i volumi desiderati o con il rullo, ottenendo una superficie più regolare.

Possono essere colorate con l'aerografo e decorate con un sac a poche, senza pericolo di rovinarle, ottenendo effetti straordinari.

## LAVAGGIO

Le alzate scomponibili sono facilmente lavabili in lavastoviglie. Le più voluminose possono comodamente essere lavate con una lancia termica a bassa temperatura.

## CONSIGLI PER DECORARE

### GHIACCIA

#### Ingredienti

1 Kg zucchero a velo  
150 gr succo limone  
150 gr bianco d'uovo

#### Preparazione

Montare in planetaria con la spatola fino ad ottenere un composto abbastanza spumoso. Aumentando o diminuendo la quantità di bianco d'uovo si ottiene una ghiaccia più o meno consistente, che permette di realizzare volumi ed effetti diversi. Spalmare il composto colorato sull'alzata con il pennello o con il rullo e rifinire con l'aerografo.

Per realizzare decorazioni con il sac a poche è necessario che il composto sia molto denso e montato il più possibile. Fare seccare il tutto fino al giorno successivo.

### CIOCCOLATO

#### Ingredienti

500 gr burro di cacao  
500 gr cioccolato (bianco latte o nero a seconda del colore desiderato)

#### Preparazione

Sciogliere gli ingredienti, amalgamarli e spruzzarli col compressore, fare asciugare. Per ottenere un effetto vellutato mettere l'alzata in congelatore e ripetere l'operazione 2 o 3 volte.

N.B. Questa decorazione è di grande effetto ma molto delicata: si rompe o scioglie molto facilmente.

### PASTIGLIAGGIO

#### Ingredienti

1 Kg zucchero a velo  
200 gr Amido frumento  
5 gr Aceto bianco  
130 gr Acqua tiepida  
10 gr Colla di pesce

#### Preparazione

Far sciogliere nell'acqua tiepida la colla di pesce precedentemente rammollita. Impastare il tutto in planetaria e utilizzare l'impasto per ricoprire le alzate. Ultimare con l'aerografo.

#### PER LA REALIZZAZIONE DI FIORI E DECORAZIONI

### CIOCCOLATO PLASTICO

#### Ingredienti

1000 gr copertura fondente  
300 gr glucosio  
150 gr sciroppo a 30° B

### CIOCCOLATO PLASTICO BIANCO

#### Ingredienti

1200 gr copertura bianca  
300 gr glucosio  
150 gr sciroppo a 30° B

#### Preparazione

Scaldare lo sciroppo a 40° incorporato alla copertura temperata. Stendere su un vassoio e ricoprire con carta da film. Raffreddare per due ore in frigo passare in raffinatrice.

## DECORATION

*Cake stand made of plastic materials can be decorated directly on their surface, without any glue, using a paint-brush to create special volumes, or with a roller to obtain a smooth surface.*

*They can be coloured by an air-brush or decorated with a sac a poche, without damage, obtaining wonderful outcomes.*

## WASHING

*You can easily clean your cake stand in a dishwasher. The bigger one can be handy washed using a high pressure cleaner.*

## INSTRUCTION FOR DECORATE

### ROYAL ICING

#### Ingredients

1 Kg powdered sugar  
150 gr lemon juice  
150 gr egg white

#### Preparation

*Beat the ingredients stiff in the planetary mixer with the spatula up to get a foamy enough mixture. Increasing or reducing the egg white you will get a more or less solid Royal Icing, which allow to make up different volumes and effects. Spread the coloured mixture on the cake stand using a paintbrush or a roller, and then finish it off with an air brush.*

*To create garnishing using a sac a poche it is necessary to make the mixture very thick and beat it stiff as foamy as possible. Let dry everything till the day after.*

### CHOCOLATE

#### Ingredients

500 gr cocoa-butter  
500 gr chocolate (white or dark, according to your favourite colour)

#### Preparation

*Melt the ingredients; mix them and spray using a compressor, then let the result dry. In order to obtain a velvet surface, lay the cake stand in the freezer and repeat this operations twice.*

*N.B. This kind of preparation makes a sensation, but it is quite fragile: it breaks and dissolves very easily.*

### SUGARPASTE

#### Ingredients

1 Kg powdered sugar  
200 gr starch of wheat  
5 gr white vinegar  
130 gr warm water  
10 gr isinglass

#### Preparation

*Dissolve in the warm water the isinglass that you soften before. Pour the ingredients in the planetary mixer and use the mixture to coat the cake stand. Complete the work with the air brush.*

#### MAKING FLOWERS AND DECORATIONS

### PLASTIC CHOCOLATE

#### Ingredients

1000 gr dark coat  
300 gr glucose  
150 gr syrup at 30° B

### WHITE PLASTIC CHOCOLATE

#### Ingredients

1200 gr white coat  
300 gr glucose  
150 gr syrup at s 30° B

#### Preparation

*Warm the syrup up to 40° mixed with the temperate coat. Spread it on a tray and cover it with a film. Lay it in the refrigerator for two hours then sieve it in the refine machine.*







CASTELLO DUE TORRI TWO TOWERS CASTLE

COD. - ITEM	MIS. - DIM.	PIANI - LEVELS	PORT.
POLY 10	130 x 80 cm - h 100 cm	(6) Ø 25 cm	70 - 75



CASTELLO MEDIEVALE MEDIEVAL CASTLE

COD. - ITEM	MIS. - DIM.	PIANI - LEVELS	PORT.
POLY 11	140 x 80 cm - h 100 cm	(8) Ø 22 cm	60 - 65

FONTANINA ELETTRICA FORNITA SU RICHIESTA (COD. FONTANINA)  
ELECTRIC FOUNTAIN ON REQUEST (CODE FONTANINA)







PALLADIO CON VENERE PALLADIUM WITH VENUS

COD. - ITEM	MIS. - DIM.	PIANI - LEVELS	PORT.
POLY 12	130 x 80 cm - h 86 cm	(4) Ø 25 cm - (1) 50x26 cm	90 - 100



MARINA THE MARINE

COD. - ITEM	MIS. - DIM.	PIANI - LEVELS	PORT.
POLY 13	120 x 89 cm - h 88 cm	(7) Ø 25 cm	80 - 90

FONTANINA ELETTRICA FORNITA SU RICHIESTA (COD. FONTANINA)  
ELECTRIC FOUNTAIN ON REQUEST (CODE FONTANINA)





## CASTELLO DA FIABA FAIRYTALE CASTLE

COD. - ITEM	MIS. - DIM.	PIANI - LEVELS	PORT.
POLY 14	130 x 80 cm - h 100 cm	Ø 22 cm	60 - 65

FONTANINA ELETTRICA FORNITA SU RICHIESTA (COD. FONTANINA)  
ELECTRIC FOUNTAIN ON REQUEST (CODE FONTANINA)



## CASTEL NOVO

COD. - ITEM	MIS. - DIM.	PIANI - LEVELS	PORT.
POLY 19	140 x 80 cm - h 98 cm	Ø 22 cm	55 - 60







## CANGURO CANGAROO

COD. - ITEM	MIS. - DIM.	PIANI - LEVELS	CONF. - PACK.
JUNIOR06	39x25 - H57 cm	Ø 24 cm	1 pcs



## PIEDONI BIG FEET

COD. - ITEM	MIS. - DIM.	PIANI - LEVELS	CONF. - PACK.
JUNIOR07	47x37 - H12 cm	Ø 30 cm	1 pcs

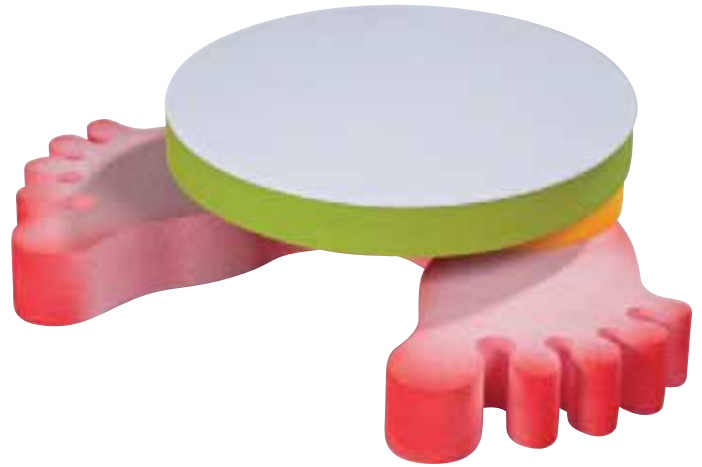

## TARTARUGA TURTLE

COD. - ITEM	MIS. - DIM.	PIANI - LEVELS	CONF. - PACK.
JUNIOR08	55x45 - H20 cm	Ø 30 cm	1 pcs

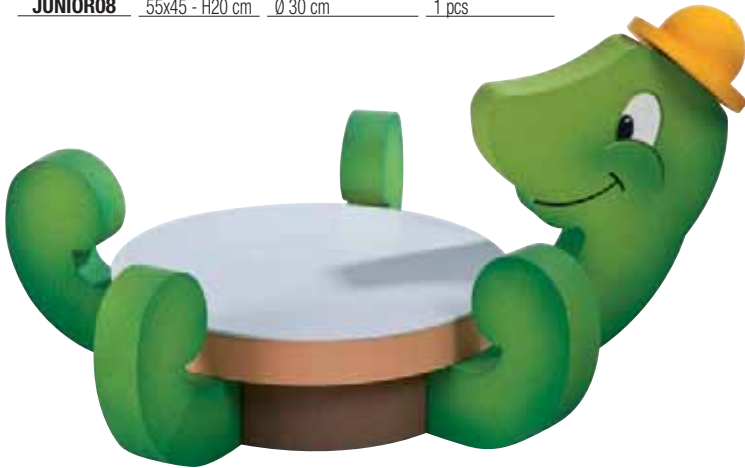

## COCCINELLA LADY BUG

COD. - ITEM	MIS. - DIM.	PIANI - LEVELS	CONF. - PACK.
JUNIOR09	50x42 - H20 cm	Ø 20 cm	1 pcs



## POLIPO OCTOPUS

COD. - ITEM	MIS. - DIM.	PIANI - LEVELS	CONF. - PACK.
JUNIOR10	60x55 - H42 cm	Ø 22 cm	1 pcs





## CICOGNA SUL TETTO STORK ON ROOF

COD. - ITEM	MIS. - DIM.	PIANI - LEVELS	PORT.
POLY 1	50 x 80 cm - h 75 cm	Ø 30 cm	12 - 15



## CONIGLIETTO BUNNY

COD. - ITEM	MIS. - DIM.	PIANI - LEVELS	PORT.
POLY 6	Ø 45 cm - h 70 cm	(2) Ø 20 cm - (1) Ø 35 cm	24 - 26





## ORSETTO TEDDY BEAR

COD. - ITEM	MIS. - DIM.	PIANI - LEVELS	PORT.
POLY 7	Ø 45 cm - h 70 cm	(1) Ø 35 cm - (2) Ø 20 cm	24 - 26



## PINOCCHIO

COD. - ITEM	MIS. - DIM.	PIANI - LEVELS	PORT.
POLY 17	45 x 51 cm - h 65 cm	Ø 30 cm	12 - 15





## CLOWN

COD. - ITEM	MIS. - DIM.	PIANI - LEVELS	PORT.
POLY 18	Ø 44 cm - h 51 cm	Ø 30 cm	12 - 15





## ALZATINE JUNIOR JUNIOR CAKE STANDS

## CONIGLIETTO BUNNY

**COD. - ITEM** **MIS. - DIM.** **PIANI - LEVELS**

**JUNIOR01** h 32 cm Ø 25 cm



## ORSETTO BEAR

**COD. - ITEM** **MIS. - DIM.** **PIANI - LEVELS**

**JUNIOR02** h 32 cm Ø 25 cm



## CLOWN

**COD. - ITEM** **MIS. - DIM.** **PIANI - LEVELS**

**JUNIOR03** h 32 cm Ø 25 cm



## PINOCCHIO

**COD. - ITEM** **MIS. - DIM.** **PIANI - LEVELS**

**JUNIOR04** h 32 cm Ø 25 cm



## COPPA CUP

**COD. - ITEM** **MIS. - DIM.** **PIANI - LEVELS**

**JUNIOR05** h 32 cm Ø 25 cm

